

Installation Instruction

Mitre Tool Typ 1001



DÖLLKEN

W E I M A R

A SURTECO COMPANY

Notching Döllken Solidcore Skirting

Important Components of the Mitre Tool

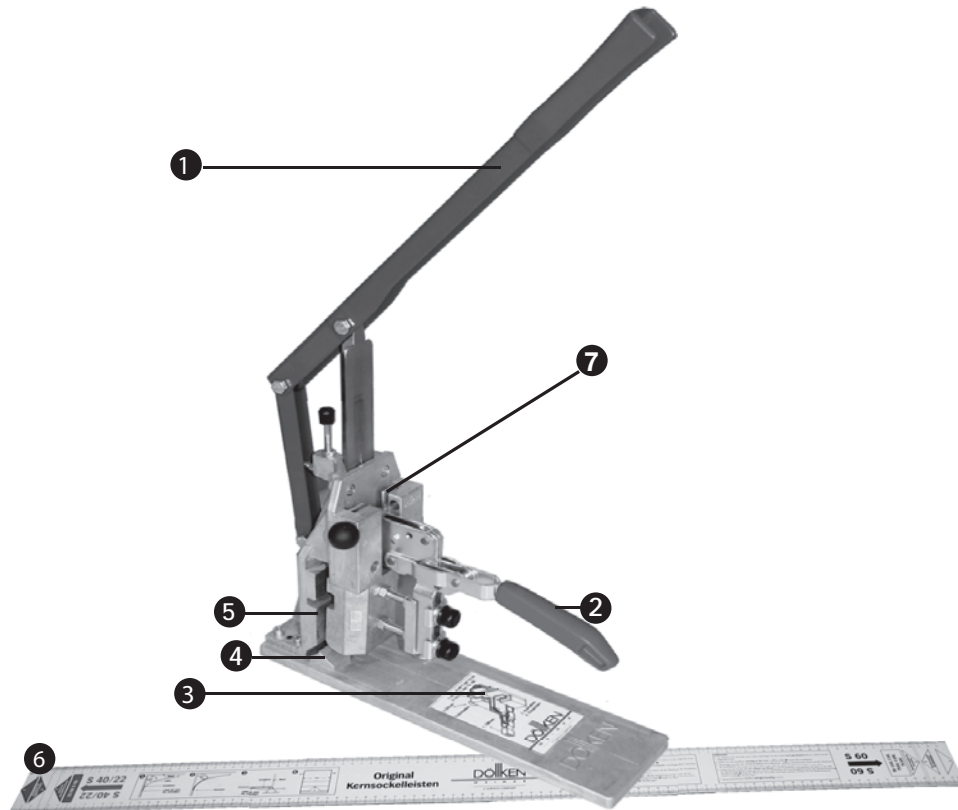

Number	Name
1	lever
2	clamping device
3	pedestal
4	trestle
5	lay-on surface
6	measuring template
7	double insertion plate

Inside Corner

Short Instruction



Position a normal ruler behind the skirting at the corner



Mark the solidcore skirting accordingly

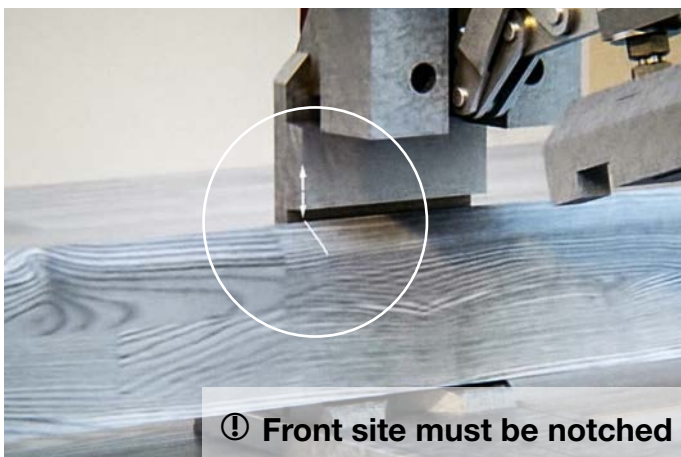

Put the mark to the border of the lay-on surface

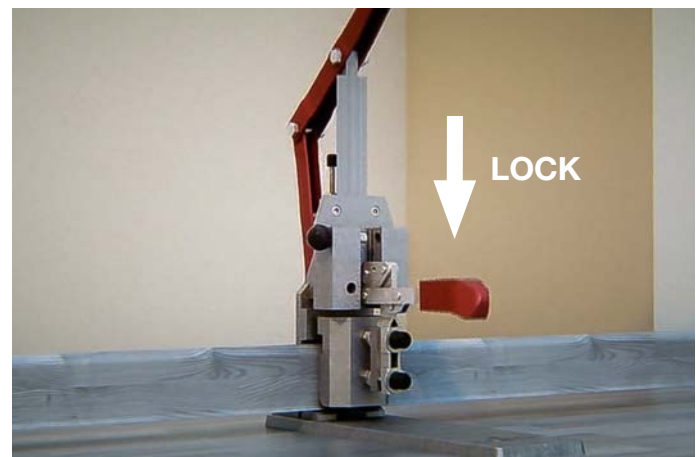

Lock the clamping device...

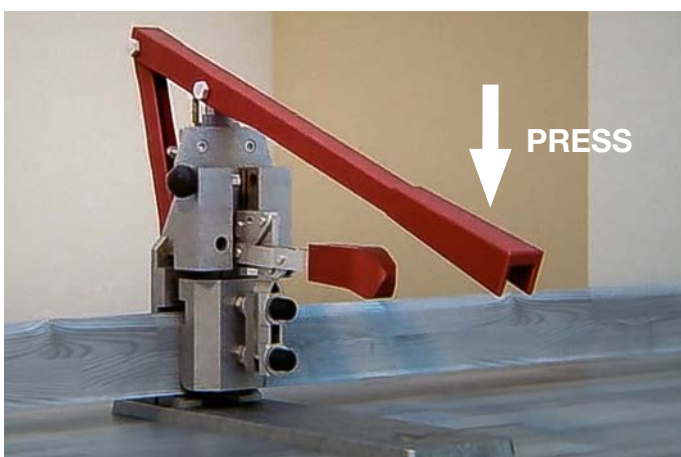

... and notch

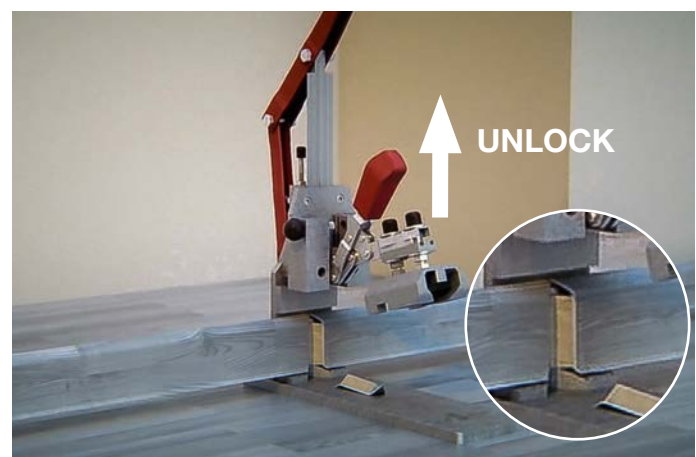

External Corner

Short instruction

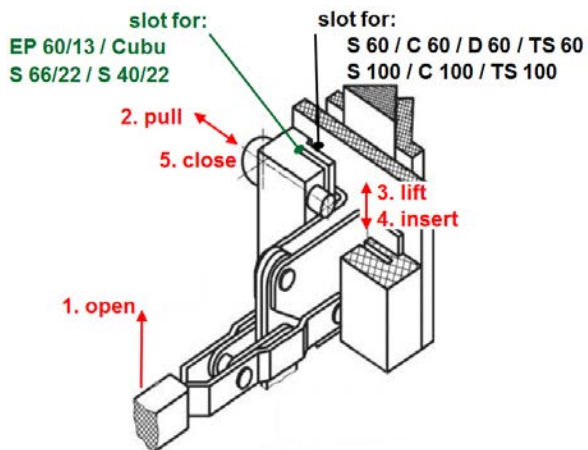

Use the correct slot in the double insertion plate



Mark the solidcore skirting accordingly

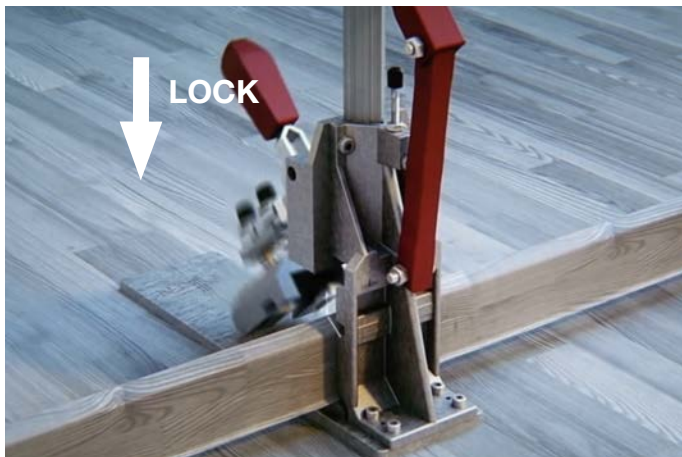

Lock the clamping device..



Put the mark to the border of the lay-on surface

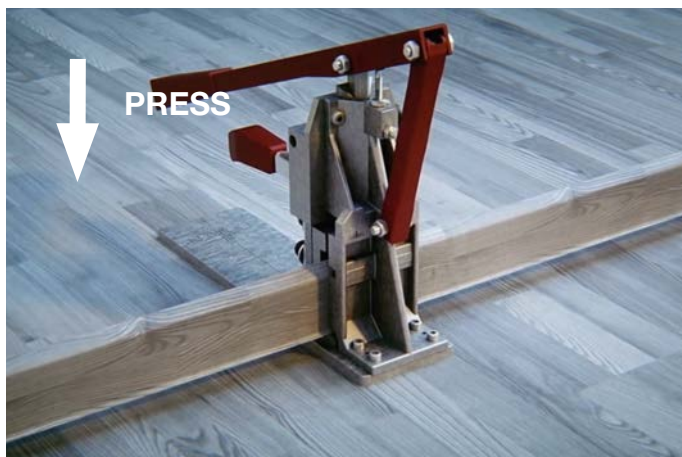

.. and notch

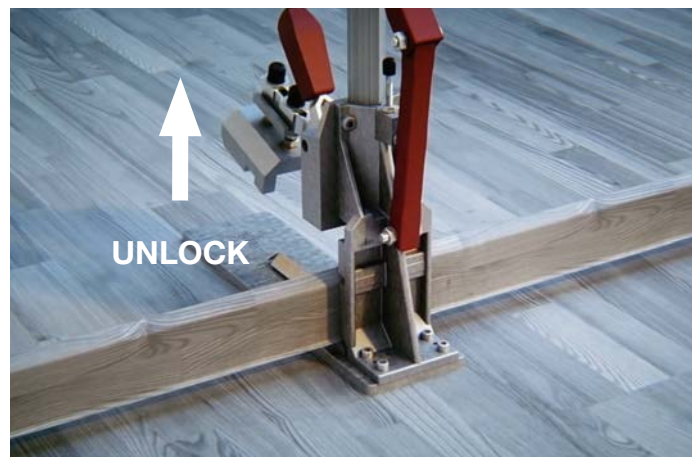

135° Corner

Short instruction

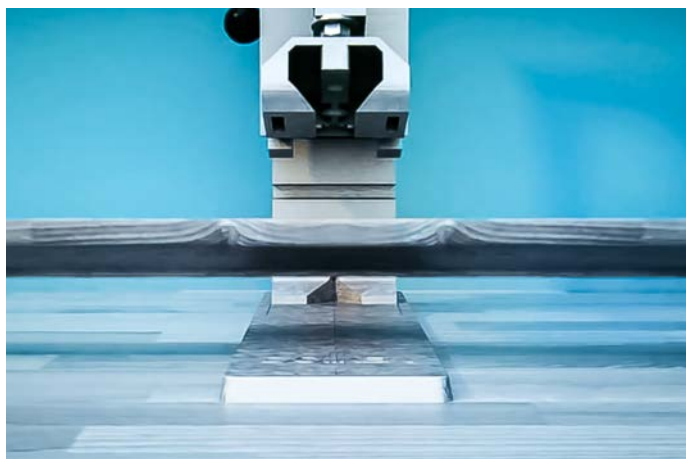

Turn the solidcore skirting on the head

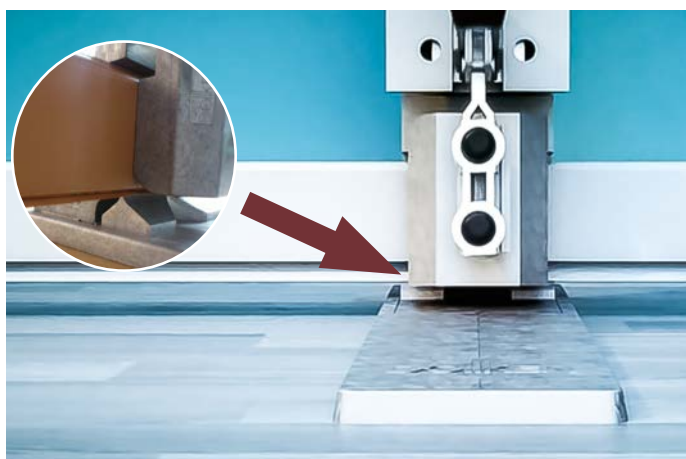

Lay in the upper flexible lip seal straight on the trestle



Notch very carefully: Stop when the resistance decrease



Cut out the bowing on the upper flexible lip

To Build End Caps

Short instruction

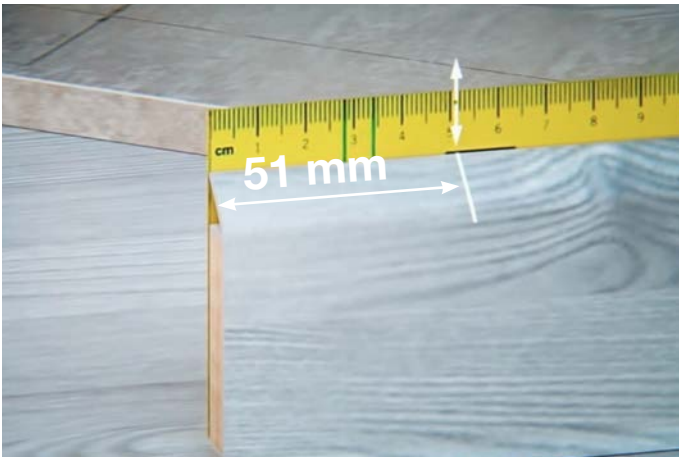

Measure back 51 mm on the profile from the end



Then apply that mark to the border of the lay-on surface

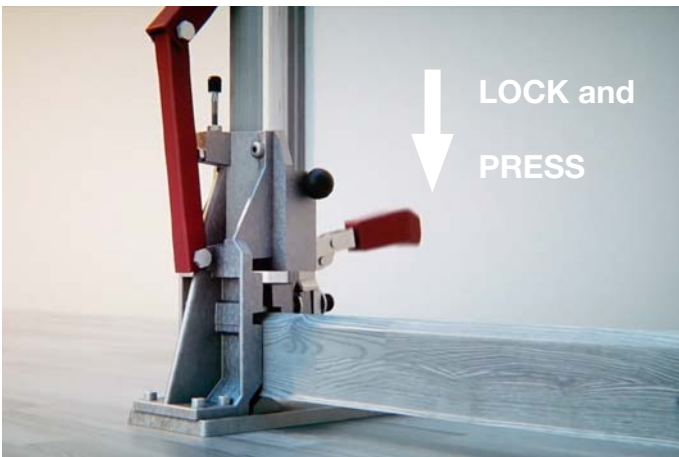

Close the clamping device and notch



Use Döllken hot melt to fix the end caps



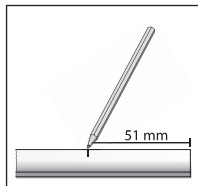

Let the end off the profile overlap with 11 mm. Measure back 51 mm on the profile from the end and mark that on the profile.

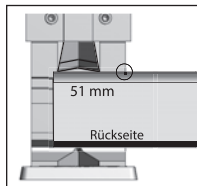

Then apply that mark at the edge of the Mitre Tool's flange, close the clamping device and notch.

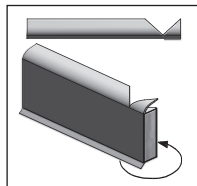

Turn the end piece around and glue the core areas.

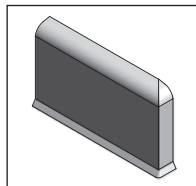

So the profile gets a pattern identical end cap at door cases, stair transitions or free ends.



Scan in the QR code and watch the installation video!

Döllken-Weimar GmbH
Gewerbegebiet U.N.O · Stangenallee 3 · 99428 Nohra · Germany
Tel.: +49 (0)3643 4170-711 · Fax: -330
info@doellken-weimar.de · www.doellken-weimar.de